







-  x 50
-  4.8x16 x 4
-  x 1
-  x 1
-  x 1
-  x 1

Montage rivetée

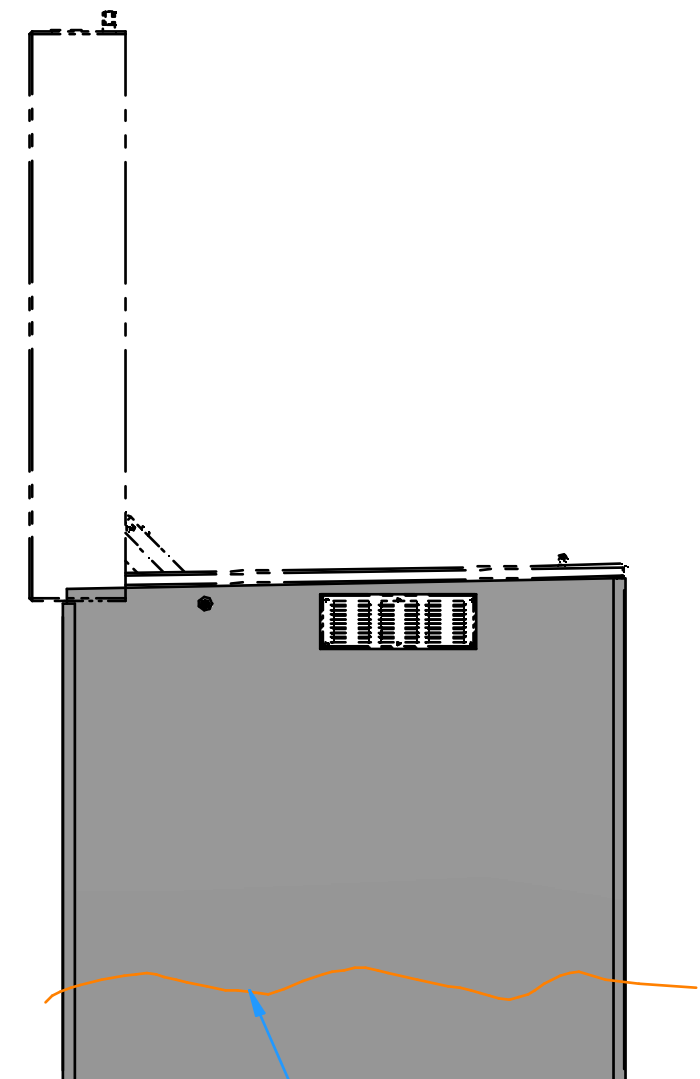

Découpe à longueur sur Site

JUPES POUR Trappe EAU POTABLE 800.800

Plan n° : ID - F 0329 - TR / Rev : A