

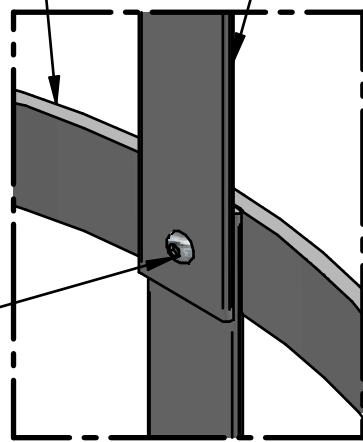

Echelle A
Pré-percée

Arceau SVR de Crinoline diam 710mm
Plan n° F 0138

Plat crinoline 3800
Plan n° U 0034



CBHC M8x30









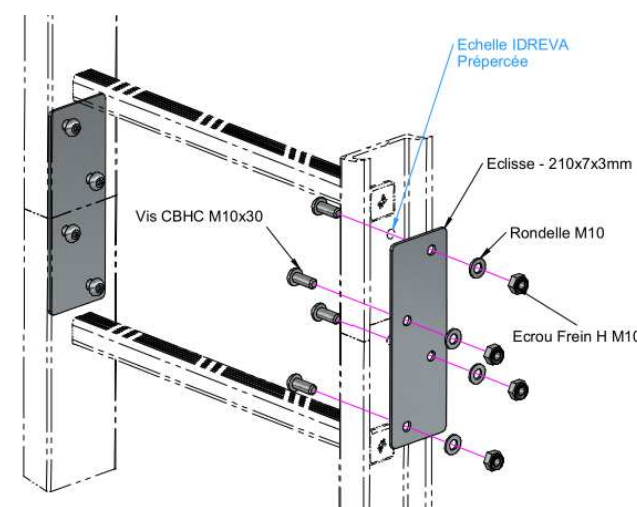
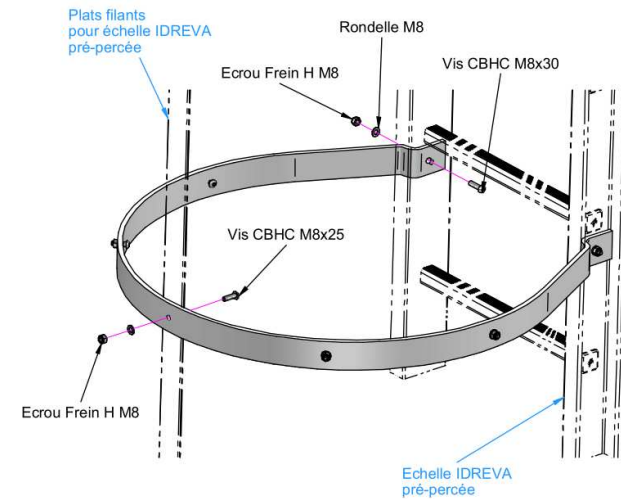



Eclisse d'Echelle
Plan n° F 0008

Plat crinoline 1550
Plan n° U 0035

Echelle B
Pré-percée

Echelle C
Pré-percée



-  x 4
-  x 5
-  x 5
-  x 8
-  x 1
-  x 1
-  x 16
-  x 16
-  x 16
-  x 61
-  x 61
-  x 21
-  x 40

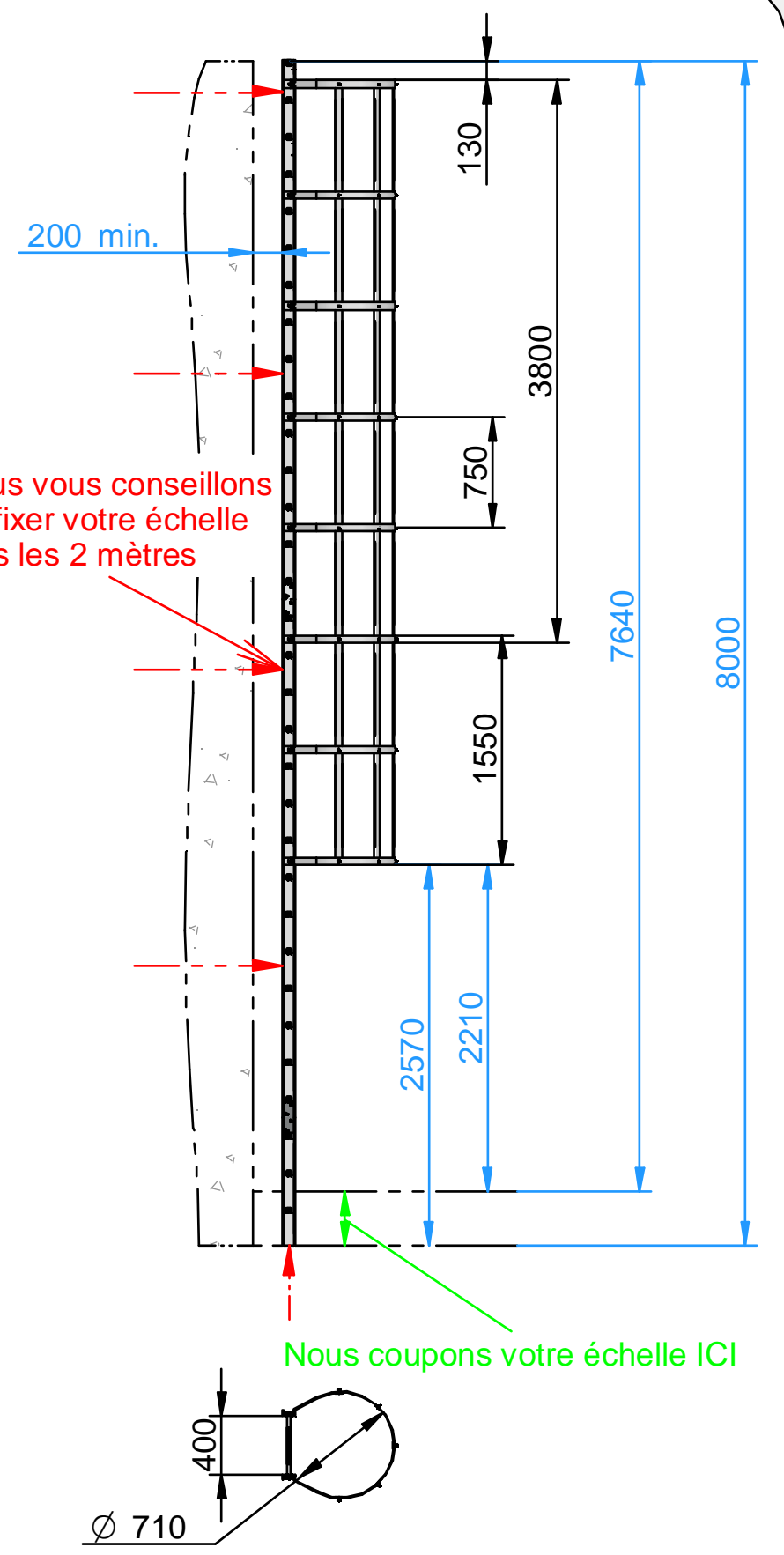

Principe Montage Echelle 7640-8000

Plan n° : ID - F 0267 - EC / Rev : A