

Main Courante Ergonomique PRV - 50x59x4mm
IDREVA

Perçages
des mains courantes
à l'aide des pré-perçages existants

Rivet 4.8 x 14

Rivet 4.8 x 14

Tube PRV - 25x18mm
IDREVA

Perçages
du poteau
à l'aide des pré-perçages existants

Rivet 4.8 x 20

Plinthe PRV - 150x12.5x3mm
IDREVA

Contre perçage plinthe
à l'aide du perçage de l'embase
aligner avec perçage du poteau

Rondelle M10

Ecrou Frein H M10

Rondelle M10





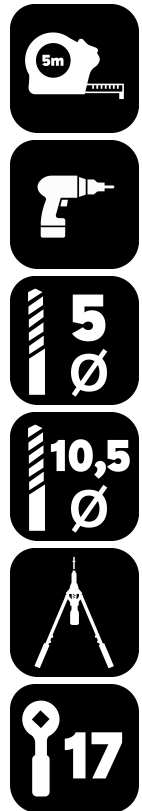

Vis H M10x90

Vis sans Tête STHC M6-10
Calage Poteau

Montage Droite

Montage Gauche

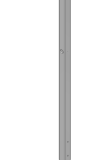

-  x 1
-  x 2
-  x 1
-  x 1
-  x 1
-  x 2
-  x 1
-  x 1

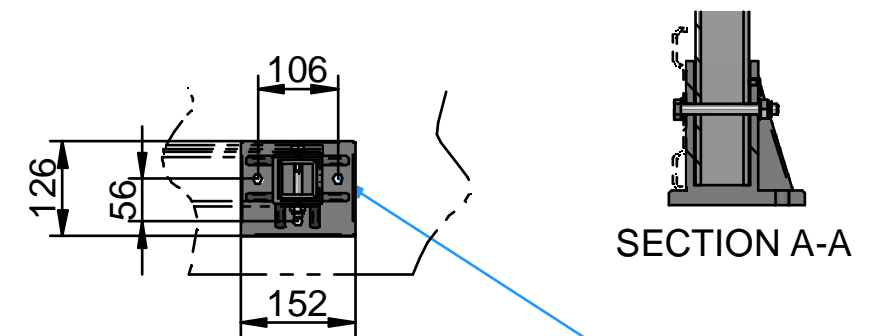
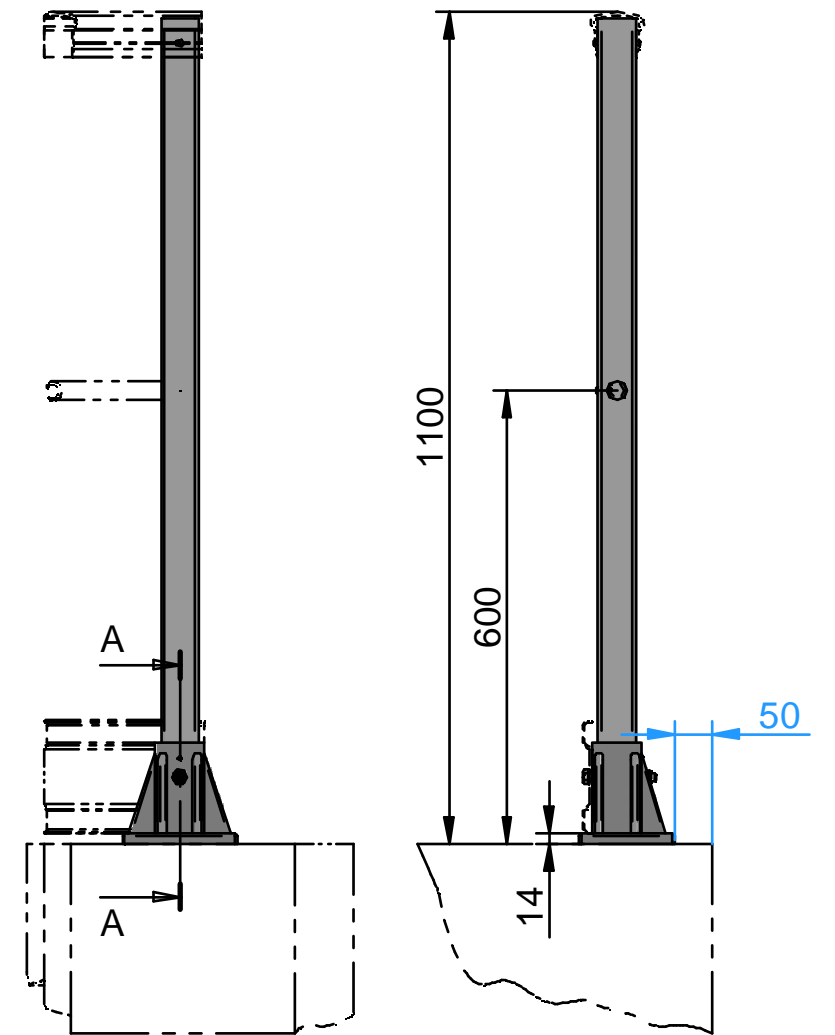

Préconisation 3 x Chevillages M 10
a adapté selon la nature du support

Poteau de Garde-corps Borgne sur embase

Plan n° : ID - F 0210 - GC

Rev : A